

# T-UNITED

*The Cap that Communicates*

Tongbo Huang

Wei Shi

Yifei Yao

Qiannan Zhang

**Objective:**

Array of interactive Caps that share and display information.

**Motivation:**

Apart from simply displaying pre-installed information, it will certainly be more fun to incorporate with other Caps via interactions.



## Competitive Analysis

- Programmable Caps, but display saved information.
- No Caps communicate with another.



- ✓ 1 Steeler Cap
- ✓ 1 Arduino LilyPad microcontroller
- ✓ 1 LED board
- ✓ 2 IRDA Transceivers
- ✓ 2 IRDA En/Decoders
- ✓ 3 AA batteries
- ✓ Wires

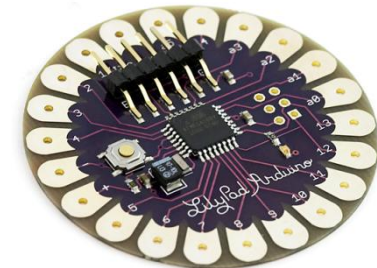
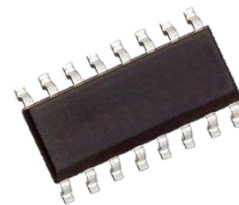
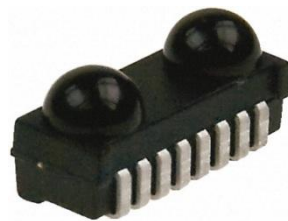

Objective

Hardware

Architecture

Results





Objective

Hardware

Architecture

Results



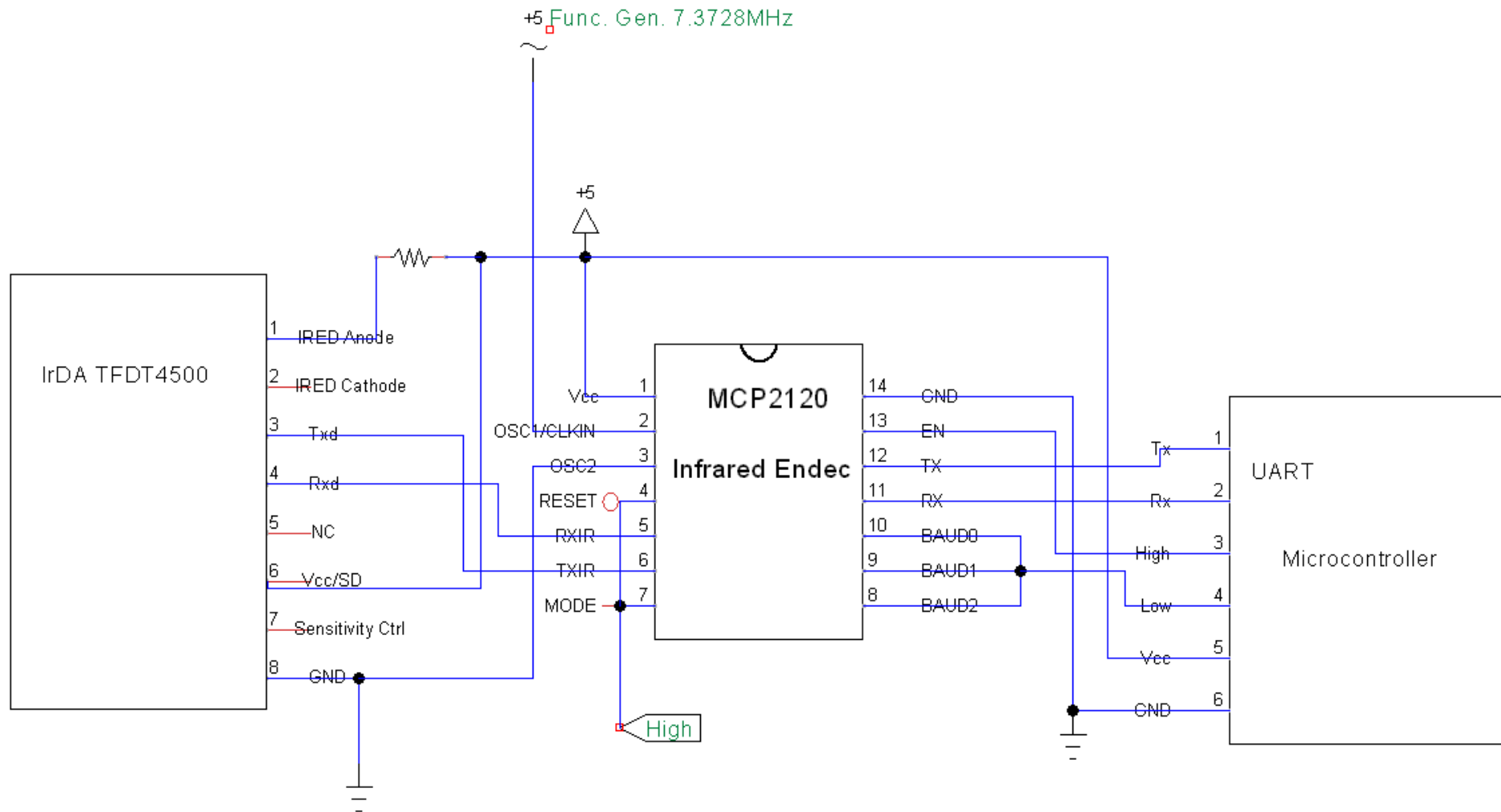

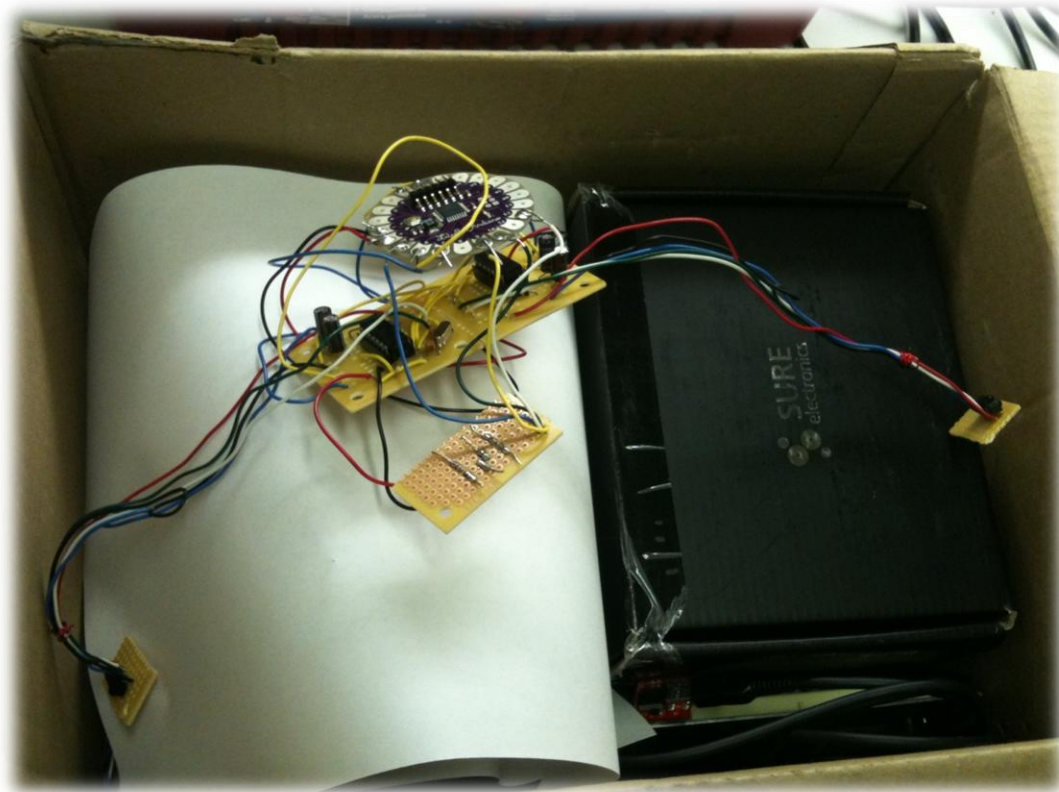

**To be packaged...**



Objective

Hardware

Architecture

Results

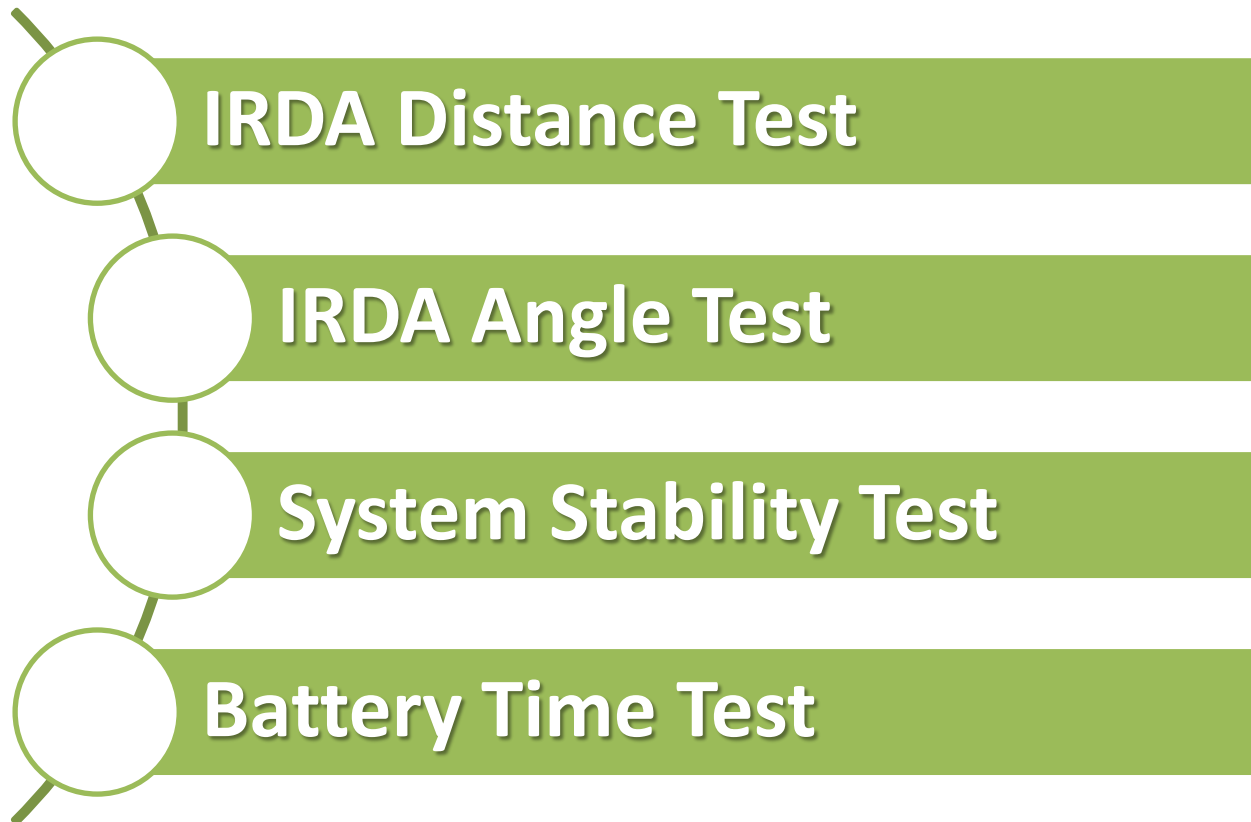

## IRDA Distance Test

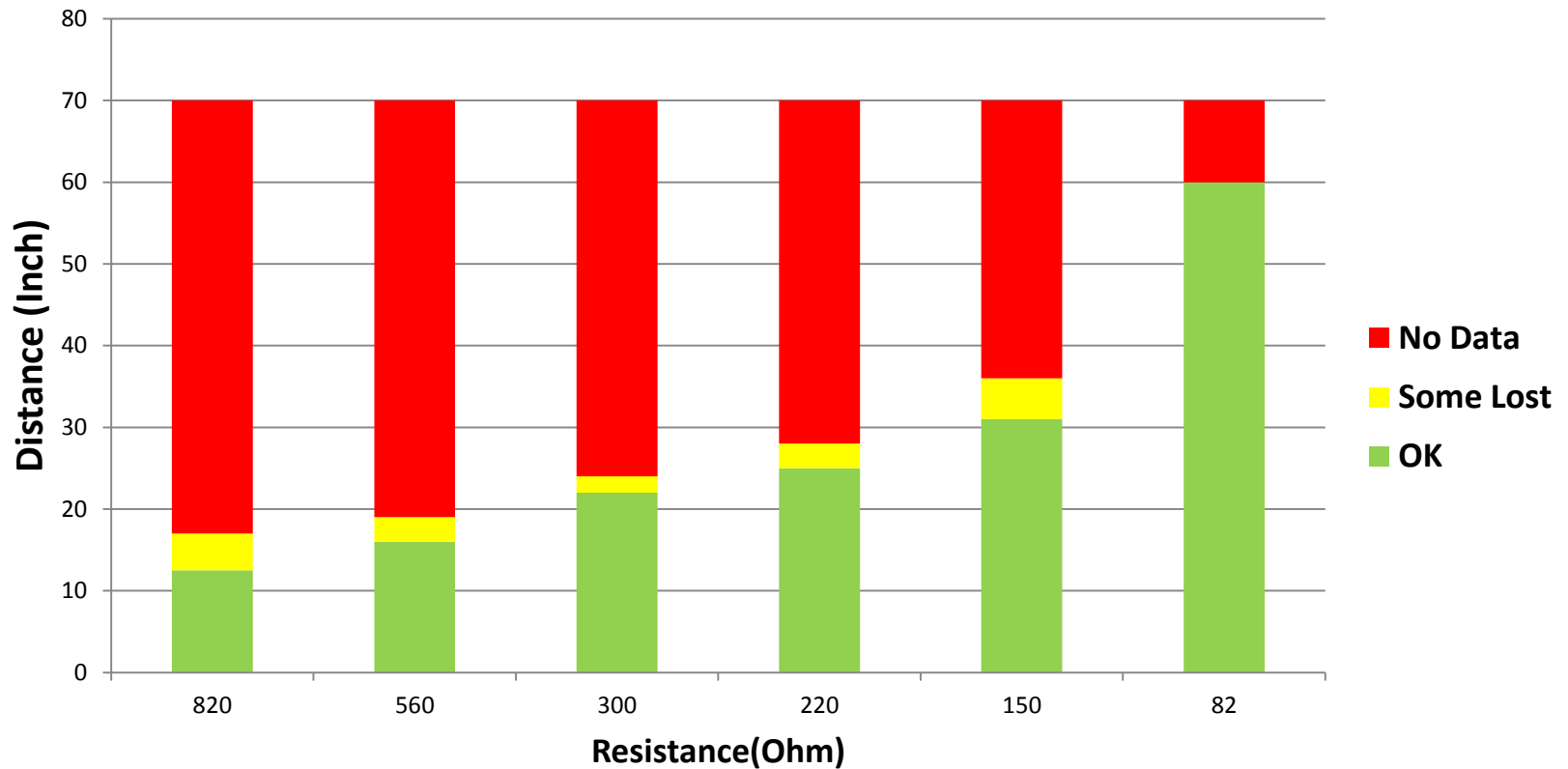

## IRDA Angle Test:

Angle	< 20 degree	20 – 25 degree	>25 degree
Data	Yes	Some Lost	No

## System Stability Test:

At least 5min

## Battery Time Test:

No data yet

## Lessons Learned

