

18-447

Computer Architecture

Lecture 12: Out-of-Order Execution (Dynamic Instruction Scheduling)

Prof. Onur Mutlu

Carnegie Mellon University

Spring 2015, 2/13/2015

Agenda for Today & Next Few Lectures

- Single-cycle Microarchitectures
- Multi-cycle and Microprogrammed Microarchitectures
- Pipelining
- Issues in Pipelining: Control & Data Dependence Handling, State Maintenance and Recovery, ...
- Out-of-Order Execution
- Issues in OoO Execution: Load-Store Handling, ...
- Alternative Approaches to Instruction Level Parallelism

Reminder: Announcements

- Lab 3 due next Friday (Feb 20)
 - Pipelined MIPS
 - Competition for high performance
 - You can optimize both cycle time and CPI
 - Document and clearly describe what you do during check-off
- Homework 3 due Feb 25
 - A lot of questions that enable you to learn the concepts via hands-on exercise
 - Remember this is all for your benefit (to learn and prepare for exams)
 - HWs have very little contribution to overall grade
 - Solutions to almost all questions are online anyway

Readings Specifically for Today

- Smith and Sohi, “The Microarchitecture of Superscalar Processors,” Proceedings of the IEEE, 1995
 - More advanced pipelining
 - Interrupt and exception handling
 - Out-of-order and superscalar execution concepts
- Kessler, “The Alpha 21264 Microprocessor,” IEEE Micro 1999.

Recap of Last Lecture

- Issues with Multi-Cycle Execution
- Exceptions vs. Interrupts
- Precise Exceptions/Interrupts
- Why Do We Want Precise Exceptions?
- How Do We Ensure Precise Exceptions?
 - Reorder buffer
 - History buffer
 - Future register file (best of both worlds)
 - Checkpointing
- Register renaming with a reorder buffer
- How to Handle Exceptions
- How to Handle Branch Mispredictions
- Speed of State Recovery: Recovery and Interrupt Latency
 - Checkpointing
- Registers vs. Memory

Important: Register Renaming with a Reorder Buffer

- Output and anti dependencies are not true dependencies
 - WHY? The same register refers to values that have nothing to do with each other
 - **They exist due to lack of register ID's (i.e. names) in the ISA**
- The register ID is **renamed** to the reorder buffer entry that will hold the register's value
 - Register ID → ROB entry ID
 - Architectural register ID → Physical register ID
 - After renaming, ROB entry ID used to refer to the register
- This eliminates anti- and output- dependencies
 - Gives the illusion that there are a large number of registers

Review: Register Renaming Examples

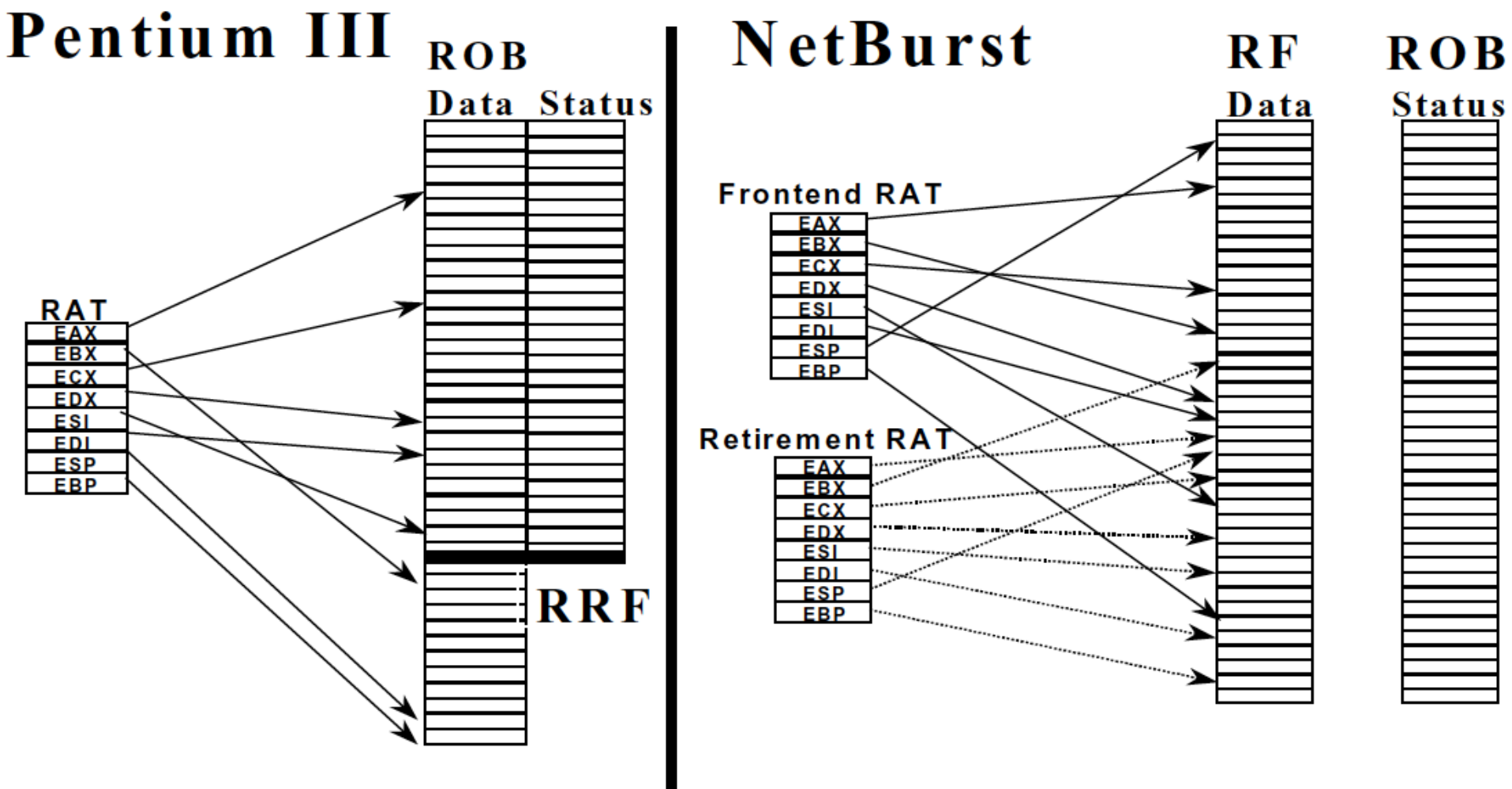

Boggs et al., "The Microarchitecture of the Pentium 4 Processor,"
Intel Technology Journal, 2001.

Review: Checkpointing Idea

- Goal: Restore the frontend state (future file) such that the correct next instruction after the branch can execute right away after the branch misprediction is resolved
- Idea: Checkpoint the frontend register state/map at the time a branch is decoded and keep the checkpointed state updated with results of instructions older than the branch
 - Upon branch misprediction, restore the checkpoint associated with the branch
- Hwu and Patt, “Checkpoint Repair for Out-of-order Execution Machines,” ISCA 1987.

Review: Checkpointing

- **When a branch is decoded**
 - Make a copy of the future file/map and associate it with the branch
- **When an instruction produces a register value**
 - All future file/map checkpoints that are younger than the instruction are updated with the value
- **When a branch misprediction is detected**
 - Restore the checkpointed future file/map for the mispredicted branch when the branch misprediction is resolved
 - Flush instructions in pipeline younger than the branch
 - Deallocate checkpoints younger than the branch

Review: Registers versus Memory

- So far, we considered mainly registers as part of state
- What about memory?
- What are the fundamental differences between registers and memory?
 - Register dependences known statically – memory dependences determined dynamically
 - Register state is small – memory state is large
 - Register state is not visible to other threads/processors – memory state is shared between threads/processors (in a shared memory multiprocessor)

Maintaining Speculative Memory State: Stores

- Handling out-of-order completion of memory operations
 - UNDOing a memory write more difficult than UNDOing a register write. **Why?**
 - **One idea:** Keep store address/data in reorder buffer
 - How does a load instruction find its data?
 - **Store/write buffer:** Similar to reorder buffer, but used only for store instructions
 - Program-order list of un-committed store operations
 - When store is decoded: Allocate a store buffer entry
 - When store address and data become available: Record in store buffer entry
 - When the store is the oldest instruction in the pipeline: Update the memory address (i.e. cache) with store data
- We will get back to this after today!

Remember:
Static vs. Dynamic Scheduling

Remember: Questions to Ponder

- What is the role of the hardware vs. the software in the order in which instructions are executed in the pipeline?
 - Software based instruction scheduling → **static scheduling**
 - Hardware based instruction scheduling → **dynamic scheduling**

- What information does the compiler not know that makes static scheduling difficult?
 - Answer: Anything that is determined at run time
 - **Variable-length operation latency, memory addr, branch direction**

Dynamic Instruction Scheduling

- Hardware has knowledge of dynamic events on a per-instruction basis (i.e., at a very fine granularity)
 - Cache misses
 - Branch mispredictions
 - Load/store addresses
- Wouldn't it be nice if hardware did the scheduling of instructions?

Out-of-Order Execution (Dynamic Instruction Scheduling)

An In-order Pipeline

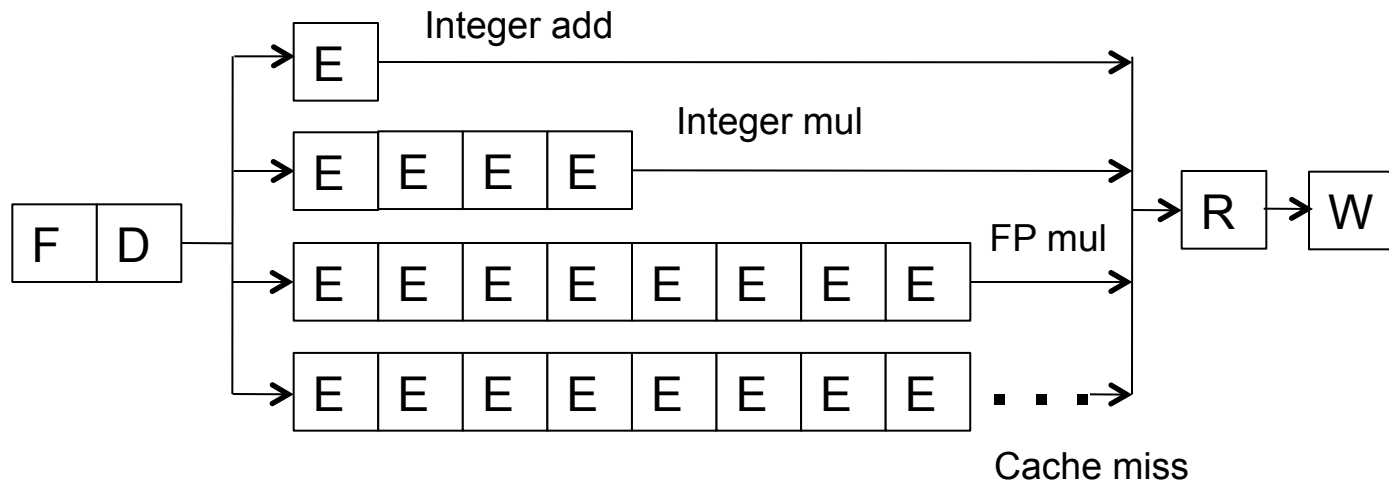

- Problem: A true data dependency stalls dispatch of younger instructions into functional (execution) units
- Dispatch: Act of sending an instruction to a functional unit

Can We Do Better?

- What do the following two pieces of code have in common (with respect to execution in the previous design)?

```
IMUL R3 ← R1, R2
ADD  R3 ← R3, R1
ADD  R1 ← R6, R7
IMUL R5 ← R6, R8
ADD  R7 ← R9, R9
```

```
LD   R3 ← R1 (0)
ADD  R3 ← R3, R1
ADD  R1 ← R6, R7
IMUL R5 ← R6, R8
ADD  R7 ← R9, R9
```

- **Answer: First ADD stalls the whole pipeline!**
 - ADD cannot dispatch because its source registers unavailable
 - **Later independent instructions cannot get executed**
- How are the above code portions different?
 - **Answer: Load latency is variable (unknown until runtime)**
 - What does this affect? Think compiler vs. microarchitecture

Preventing Dispatch Stalls

- Multiple ways of doing it
- You have already seen at least THREE:
 - 1.
 - 2.
 - 3.
- What are the disadvantages of the above three?
- Any other way to prevent dispatch stalls?
 - Actually, you have briefly seen the basic idea before
 - Dataflow: fetch and “fire” an instruction when its inputs are ready
 - Problem: **in-order dispatch (scheduling, or execution)**
 - Solution: **out-of-order dispatch (scheduling, or execution)**

Out-of-order Execution (Dynamic Scheduling)

- Idea: Move the dependent instructions out of the way of independent ones (s.t. independent ones can execute)
 - Rest areas for dependent instructions: Reservation stations
- Monitor the source “values” of each instruction in the resting area
- When all source “values” of an instruction are available, “fire” (i.e. dispatch) the instruction
 - Instructions dispatched in **dataflow (not control-flow) order**
- Benefit:
 - **Latency tolerance**: Allows independent instructions to execute and complete in the presence of a long latency operation

In-order vs. Out-of-order Dispatch

- In order dispatch + precise exceptions:

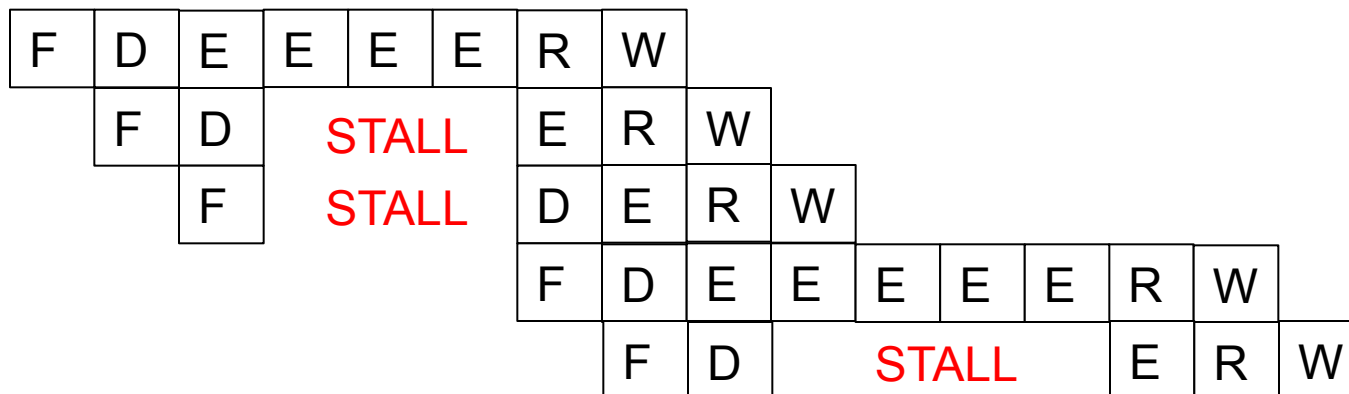

IMUL R3 ← R1, R2
 ADD R3 ← R3, R1
 ADD R1 ← R6, R7
 IMUL R5 ← R6, R8
 ADD R7 ← R3, R5

- Out-of-order dispatch + precise exceptions:

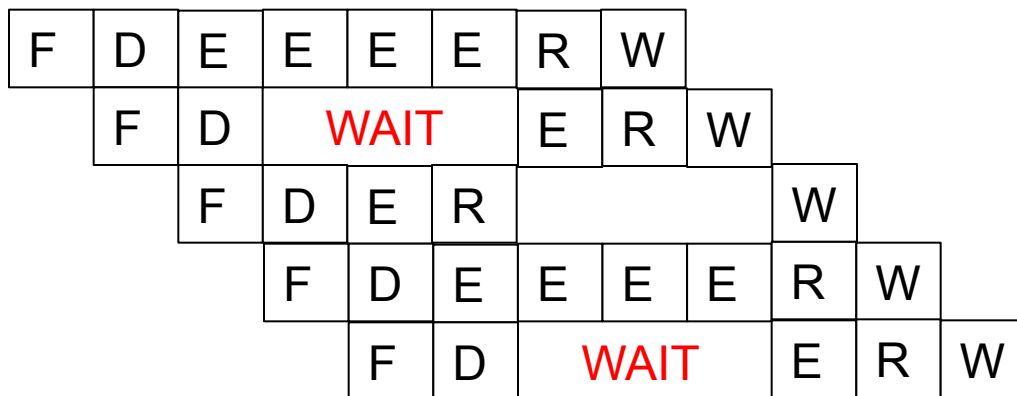

This slide is actually correct

- 16 vs. 12 cycles

Enabling OoO Execution

1. Need to link the consumer of a value to the producer
 - ❑ Register renaming: Associate a “tag” with each data value
2. Need to buffer instructions until they are ready to execute
 - ❑ Insert instruction into reservation stations after renaming
3. Instructions need to keep track of readiness of source values
 - ❑ Broadcast the “tag” when the value is produced
 - ❑ Instructions compare their “source tags” to the broadcast tag
→ if match, source value becomes ready
4. When all source values of an instruction are ready, need to dispatch the instruction to its functional unit (FU)
 - ❑ Instruction wakes up if all sources are ready
 - ❑ If multiple instructions are awake, need to select one per FU

Tomasulo's Algorithm

- OoO with register renaming invented by Robert Tomasulo
 - Used in IBM 360/91 Floating Point Units
 - **Read:** Tomasulo, “**An Efficient Algorithm for Exploiting Multiple Arithmetic Units,**” IBM Journal of R&D, Jan. 1967.
- What is the major difference today?
 - **Precise exceptions:** IBM 360/91 did NOT have this
 - Patt, Hwu, Shebanow, “**HPS, a new microarchitecture: rationale and introduction,**” MICRO 1985.
 - Patt et al., “**Critical issues regarding HPS, a high performance microarchitecture,**” MICRO 1985.
- Variants are used in most high-performance processors
 - Initially in Intel Pentium Pro, AMD K5
 - Alpha 21264, MIPS R10000, IBM POWER5, IBM z196, Oracle UltraSPARC T4, ARM Cortex A15

Two Humps in a Modern Pipeline

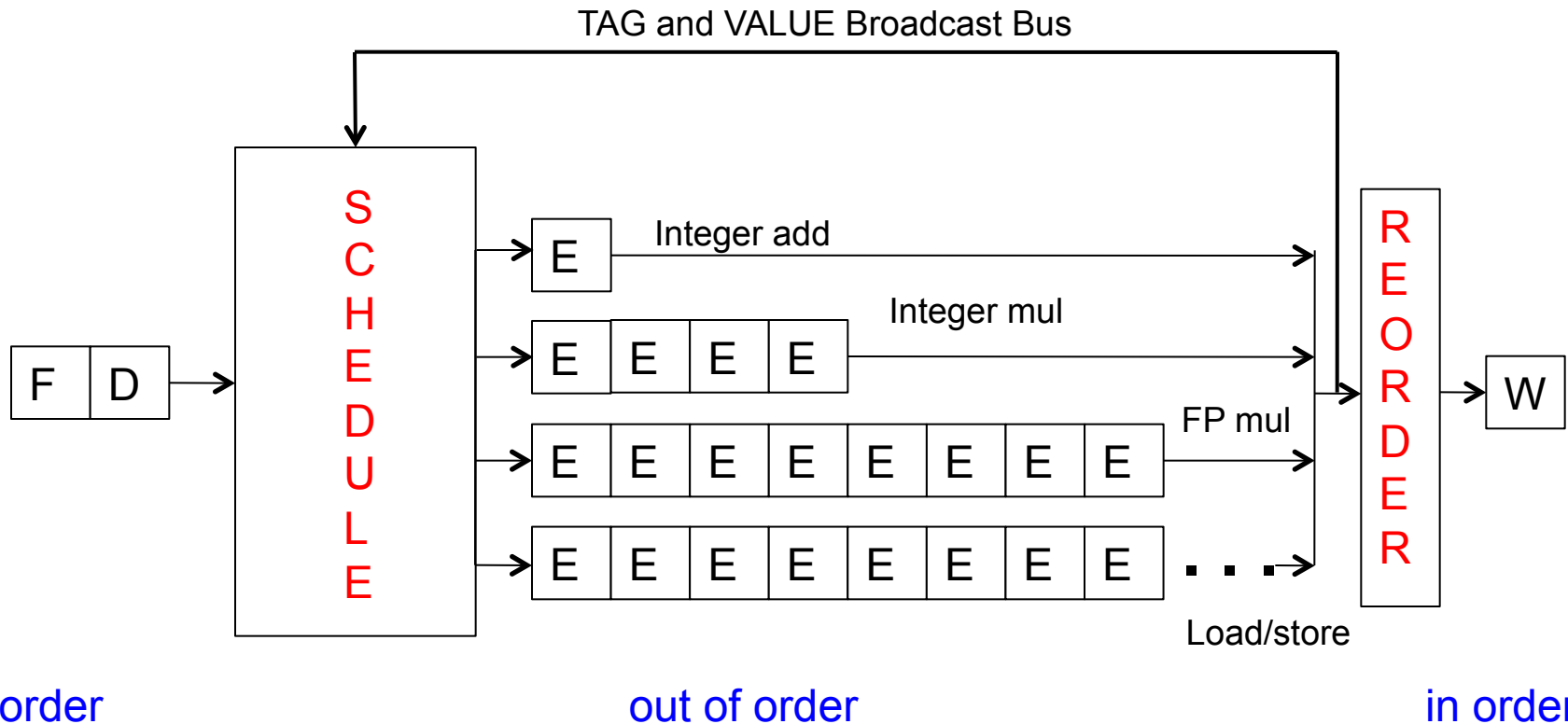

- Hump 1: Reservation stations (scheduling window)
- Hump 2: Reordering (reorder buffer, aka instruction window or active window)

General Organization of an OOO Processor

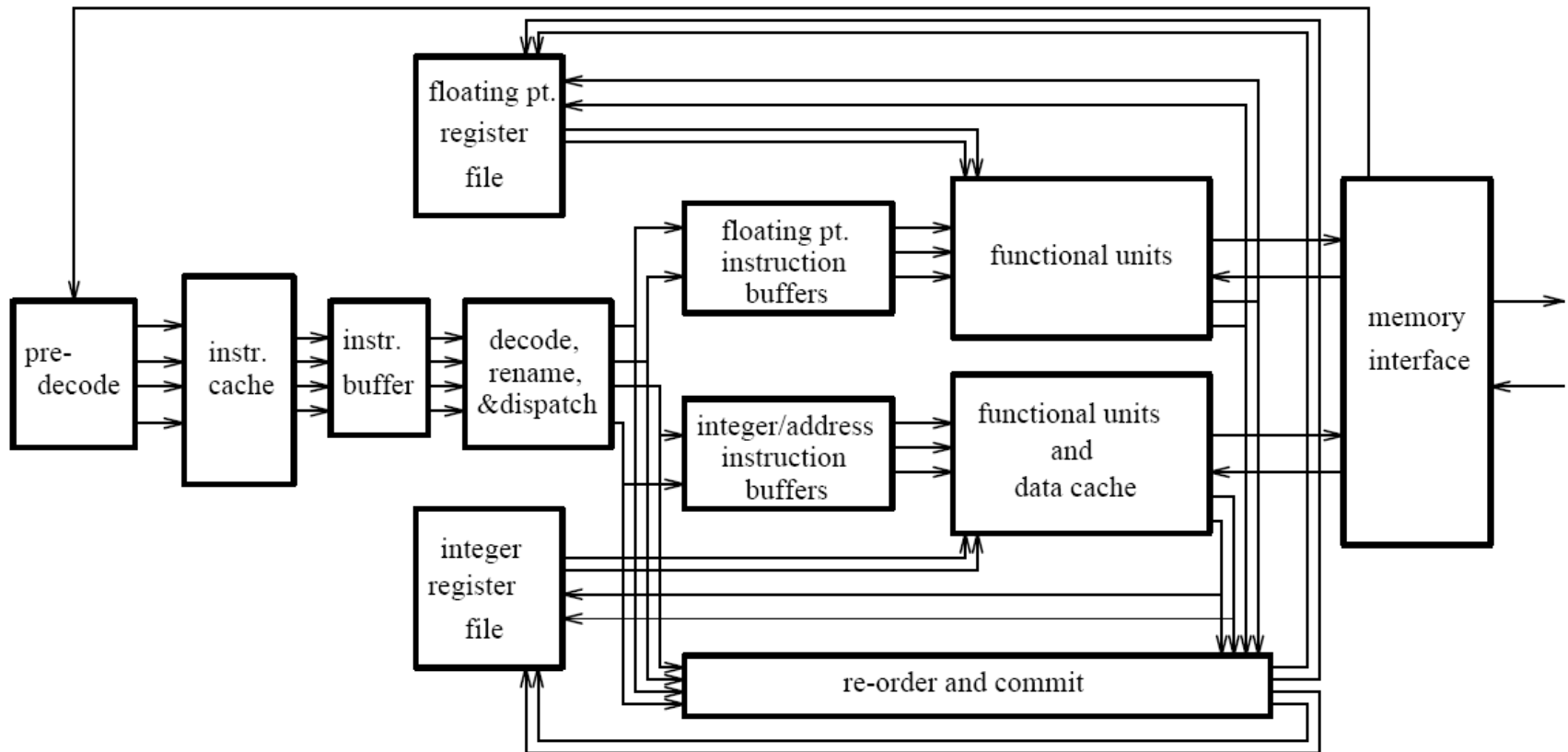

- Smith and Sohi, “**The Microarchitecture of Superscalar Processors,**” Proc. IEEE, Dec. 1995.

Tomasulo's Machine: IBM 360/91

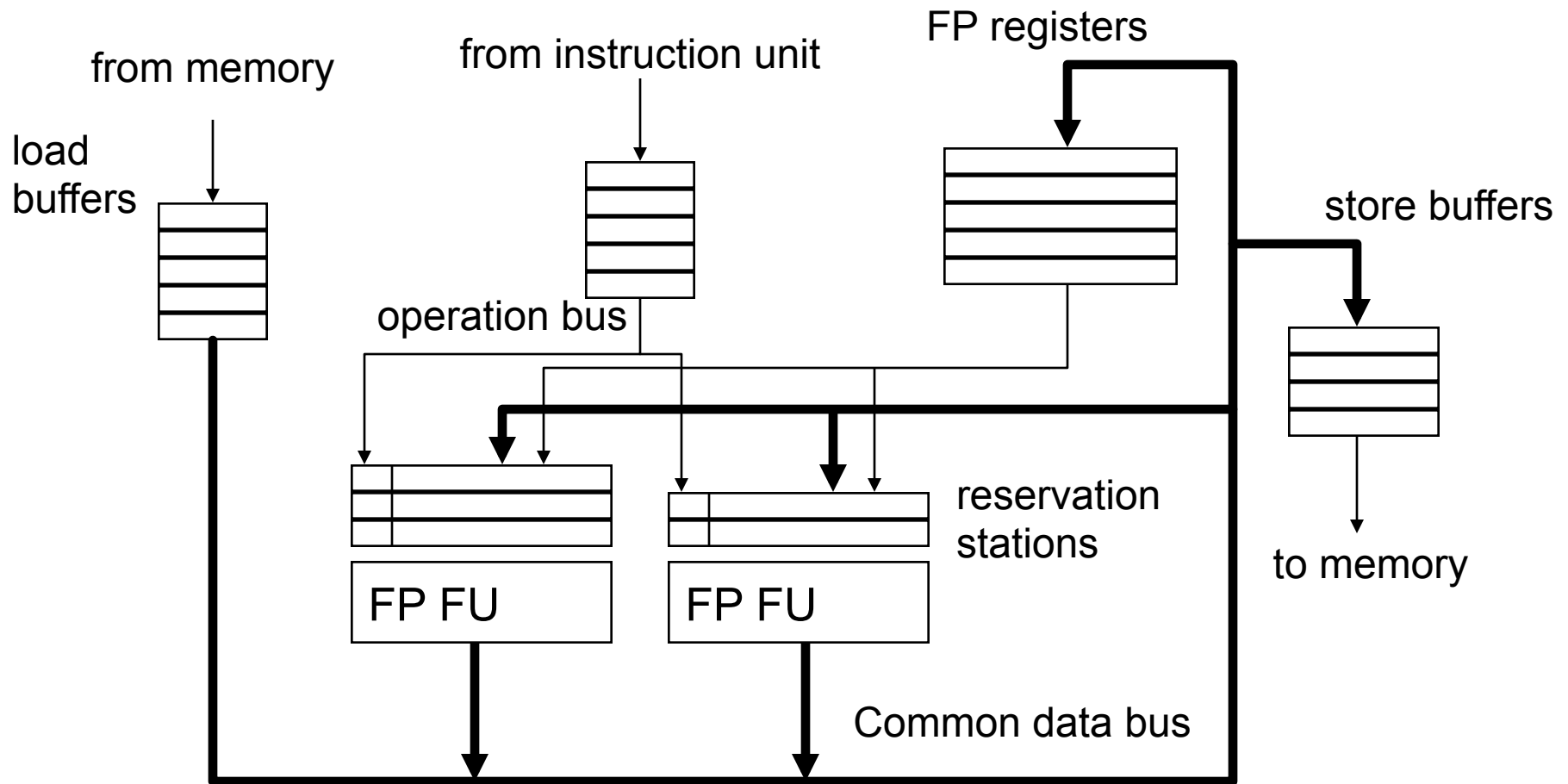

Register Renaming

- Output and anti dependencies are not true dependencies
 - WHY? The same register refers to values that have nothing to do with each other
 - **They exist because not enough register ID' s (i.e. names) in the ISA**
- The register ID is **renamed** to the reservation station entry that will hold the register' s value
 - Register ID → RS entry ID
 - Architectural register ID → Physical register ID
 - After renaming, RS entry ID used to refer to the register
- This eliminates anti- and output- dependencies
 - Approximates the performance effect of a large number of registers even though ISA has a small number

Tomasulo's Algorithm: Renaming

- Register rename table (register alias table)

	tag	value	valid?
R0			1
R1			1
R2			1
R3			1
R4			1
R5			1
R6			1
R7			1
R8			1
R9			1

Tomasulo's Algorithm

- If reservation station available before renaming
 - Instruction + renamed operands (source value/tag) inserted into the reservation station
 - Only rename if reservation station is available
- Else stall
- While in reservation station, each instruction:
 - Watches common data bus (CDB) for tag of its sources
 - When tag seen, grab value for the source and keep it in the reservation station
 - When both operands available, instruction ready to be dispatched
- Dispatch instruction to the Functional Unit when instruction is ready
- After instruction finishes in the Functional Unit
 - Arbitrate for CDB
 - Put tagged value onto CDB (tag broadcast)
 - Register file is connected to the CDB
 - Register contains a tag indicating the latest writer to the register
 - If the tag in the register file matches the broadcast tag, write broadcast value into register (and set valid bit)
 - Reclaim rename tag
 - no valid copy of tag in system!

An Exercise

MUL R3 \leftarrow R1, R2

ADD R5 \leftarrow R3, R4

ADD R7 \leftarrow R2, R6

ADD R10 \leftarrow R8, R9

MUL R11 \leftarrow R7, R10

ADD R5 \leftarrow R5, R11

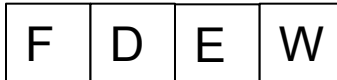

- Assume ADD (4 cycle execute), MUL (6 cycle execute)
- Assume one adder and one multiplier
- How many cycles
 - in a non-pipelined machine
 - in an in-order-dispatch pipelined machine with imprecise exceptions (no forwarding and full forwarding)
 - in an out-of-order dispatch pipelined machine imprecise exceptions (full forwarding)

Exercise Continued

Pipeline structure

MUL R1, R2, → R3
ADD R3, R4 → R5
ADD R2, R6 → R7
ADD R8, R9 → R10
MUL R7, R10 → R11
ADD R5, R11, → R5

F D E W

↓
can take
multiple
cycles

MUL takes 6 cycles
ADD takes 4 cycles

How many cycles total w/o data forwarding?
" " " " w/ " " ?

Exercise Continued

```

FD123456W
FD-----D1234W
F-----D1234W
          FD1234W
          FD-----D123456W
          F-----D          D1234W
    
```



Execution timeline w/ scoreboarding

31 cycles

```

FD123456W
FD      → E, 1234W
F       D 1 2 3 4 W
        FD1234W
        FD      → 1 2 3 4.. 5 6 W
        F       D      → 1 2 3 4 W
    
```

25 cycles

Exercise Continued

MUL R3 ← R1, R2
ADD R5 ← R3, R4
ADD R7 ← R2, R6
ADD R10 ← R8, R9
MUL R11 ← R7, R10
ADD R5 ← R5, R11

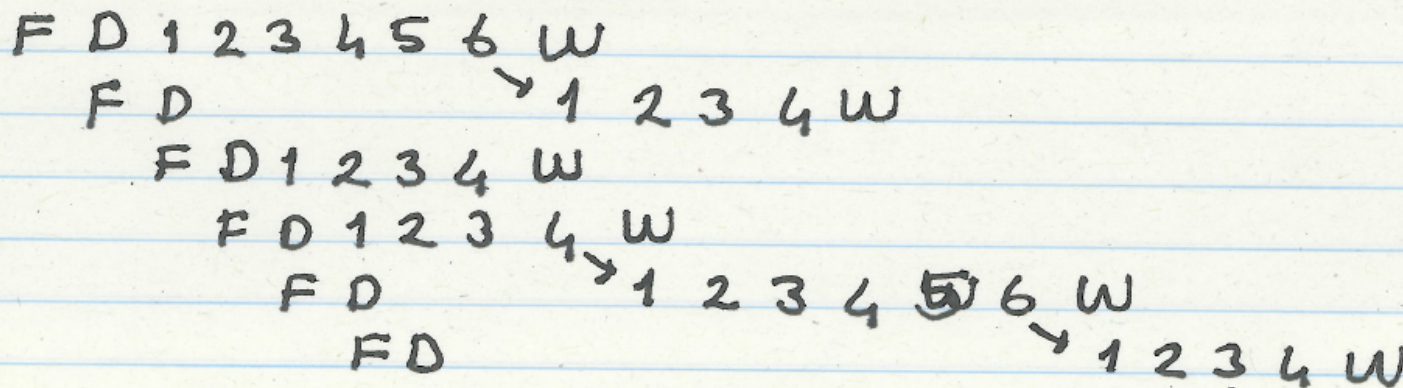

Tomasulo's algorithm + full forwarding

20 cycles

How It Works

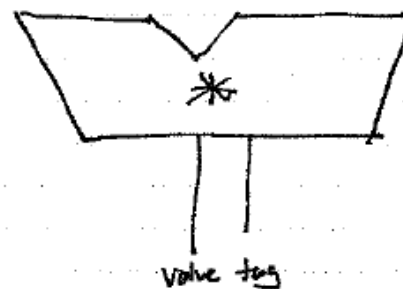
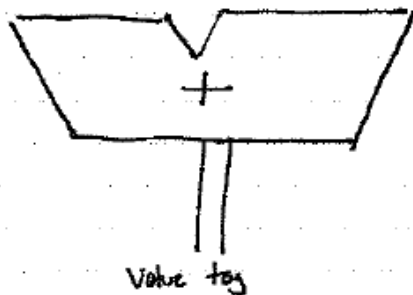
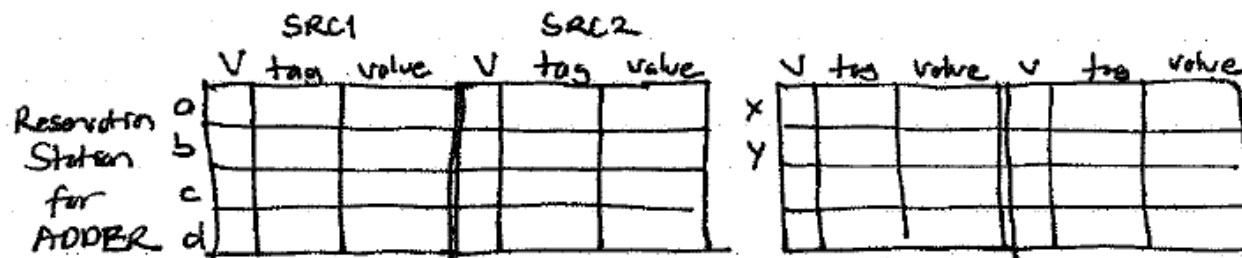
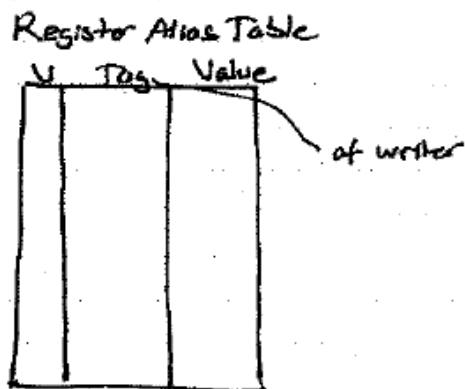

Assume
adder &
multiplier have
separate
buses

Cycle 2

cycle 2: MUL R1, R2 → R3 reads its sources from the RAT

- writes to its destination in the RAT (renames its destination)
- allocates a reservation station entry
- allocates a tag for its destination register

- places its sources in the reservation station entry that is allocated.

End of cycle 2:

	V	tag	value
R1	1	~	1
R2	1	~	2
R3	0	X	~
R4	1	~	4
R11	1	~	11

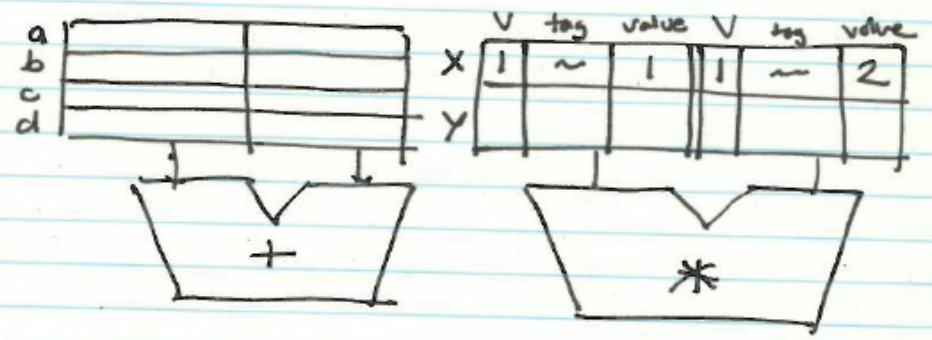

- MUL at X becomes ready to execute (and if multiple instructions become ready at the same time)
- both of its sources are valid in the reservation station X

cycle 3:

→ MUL at X starts execution

→ ADD R3, R4, → RS gets renamed and placed into the ADDPER reservation stations

end of cycle 3:

R1	1	~	1
R2	1	~	2
R3	0	X	~
R4	1	~	4
R5	0	9	~
R6	1	~	6
R11	1	~	11

	V	tag	value	V	tag	value
a	0	X	~	1	~	4
b	1					
c						
d						

X	1	~	1	1	~	2
Y						

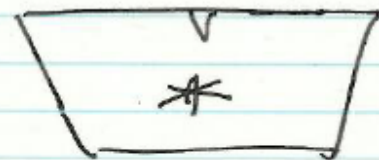
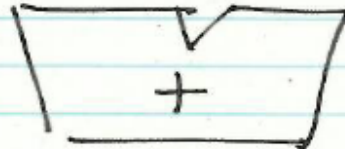

- ADD at a cannot be ready to execute because one of its sources is not ready

→ It is waiting for the value with the tag X to be broadcast (by the MUL in X)

Cycle 3

Aside: Does the tag need to be associated with the RS entry of the producer?

Answer: No: Tag is a tag for the value that is communicated.

← enables data-flow like value communication

RS is a place to hold the instructions while they become ready.

These two are completely orthogonal.

Cycle 4

cycle 4: — ADD R2, R6 → R7 gets renamed and placed into RS (5)

end of cycle 4:

R1	1	~	1
R2	1	~	2
R3	0	X	~
R4	1	~	4
RS	0	a	~
R6	1	~	6
R7	0	b	~
R11	1	~	11

a	0	X	~	1	~	4
b	1	~	2	1	~	6
c						
d						

Same as cycle 3

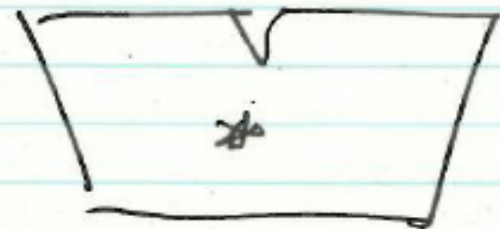
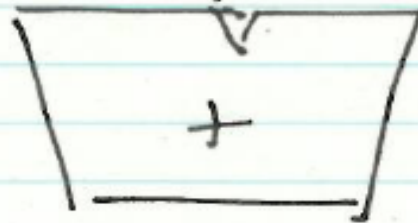

— ADD at b becomes ready to execute (both sources are ready!)

— At cycle 5, it is sent to the adder out-of-program order!

→ It is executed before the add in a

Cycle 7

end of cycle 7:

	V	tag	value
R1	1	~	1
R2	1	~	2
R3	0	X	~
R4	1	~	4
R5	0	d	~
R6	1	~	6
R7	0	b	~
R8	1	~	8
R9	1	~	9
R10	0	c	~
R11	0	Y	~

a	0	X	~	1	~	4
b	1	~	2	1	~	6
c	1	~	8	1	~	9
d	0	a	~	0	Y	~

x	1	~	1	1	~	2
y	0	b	~	0	c	~

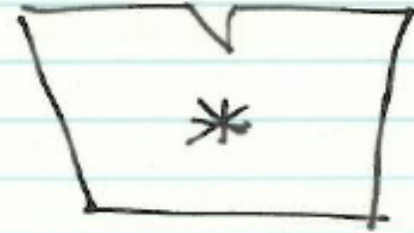
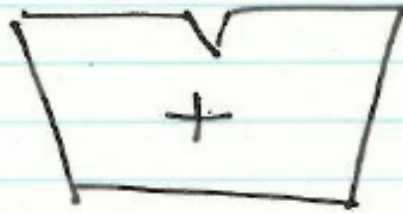

- * All 6 instructions renamed.
- Note what happened to R5

Cycle 8

cycle 8:

- MUL at X and ADD at b
broadcast their tags and values

- RS entries waiting for these tags capture the values
and set the Valid bit accordingly

→ (What is needed in HW to accomplish this?)

CAM on tags that are broadcast for all RS
entries & sources

- RAT entries waiting for these tags also capture the
values and set the Valid bits accordingly

(6)

Some Questions

- What is needed in hardware to perform tag broadcast and value capture?
 - make a value valid
 - wake up an instruction
- Does the tag have to be the ID of the Reservation Station Entry?
- What can potentially become the critical path?
 - Tag broadcast → value capture → instruction wake up
- How can you reduce the potential critical paths?

An Exercise, with Precise Exceptions

MUL R3 \leftarrow R1, R2
ADD R5 \leftarrow R3, R4
ADD R7 \leftarrow R2, R6
ADD R10 \leftarrow R8, R9
MUL R11 \leftarrow R7, R10
ADD R5 \leftarrow R5, R11

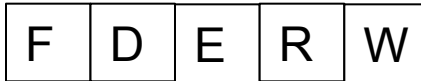

- Assume ADD (4 cycle execute), MUL (6 cycle execute)
- Assume one adder and one multiplier
- How many cycles
 - in a non-pipelined machine
 - in an in-order-dispatch pipelined machine with reorder buffer (no forwarding and full forwarding)
 - in an out-of-order dispatch pipelined machine with reorder buffer (full forwarding)

Out-of-Order Execution with Precise Exceptions

- **Idea:** Use a reorder buffer to reorder instructions before committing them to architectural state
- An instruction updates the register alias table (essentially a future file) when it completes execution
- An instruction updates the **architectural register file** when it is the oldest in the machine and has completed execution

Out-of-Order Execution with Precise Exceptions

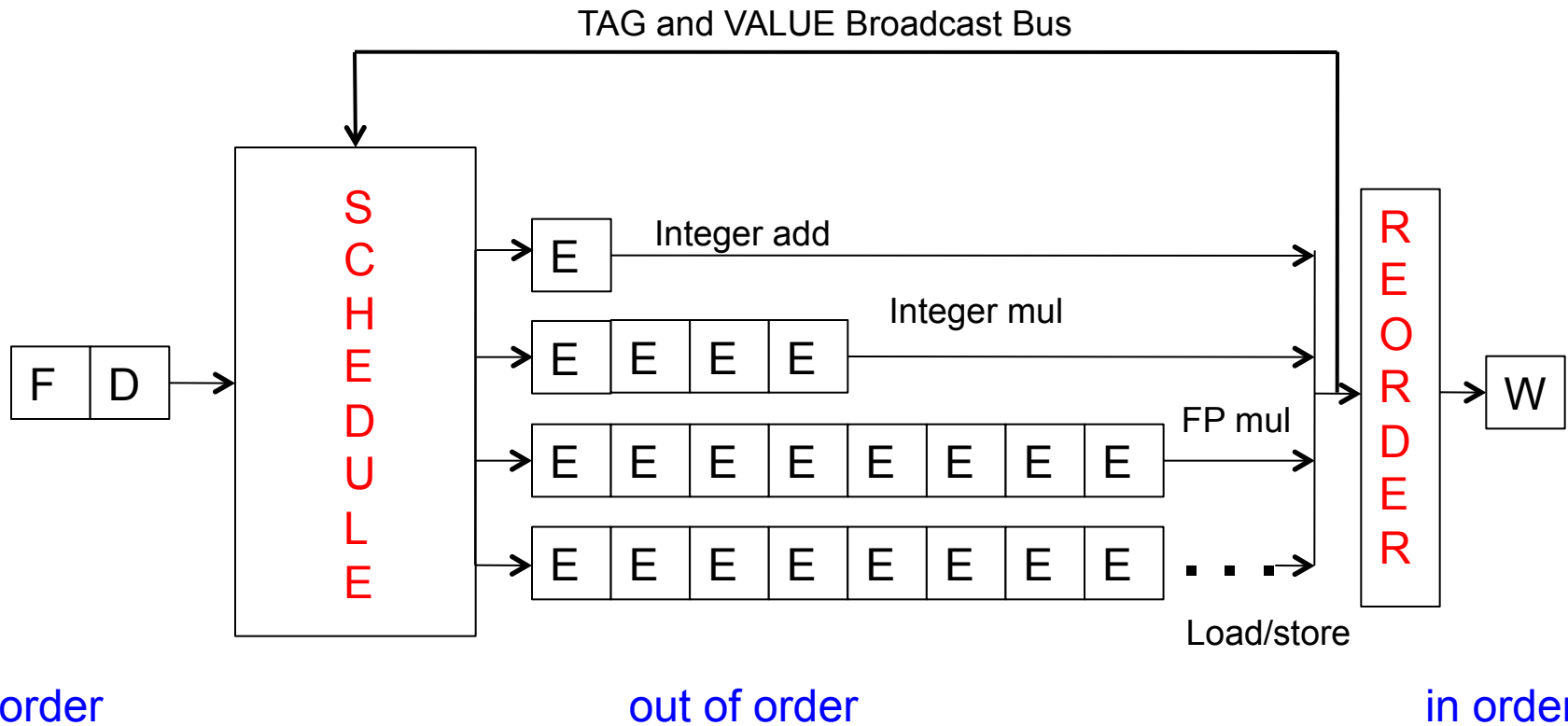

- Hump 1: Reservation stations (scheduling window)
- Hump 2: Reordering (reorder buffer, aka instruction window or active window)

Modern OoO Execution w/ Precise Exceptions

- Most modern processors use
 - Reorder buffer to support in-order retirement of instructions
 - A single register file to store registers (speculative and architectural) – INT and FP are still separate
 - Future register map → used for renaming
 - Architectural register map → used for state recovery

An Example from Modern Processors

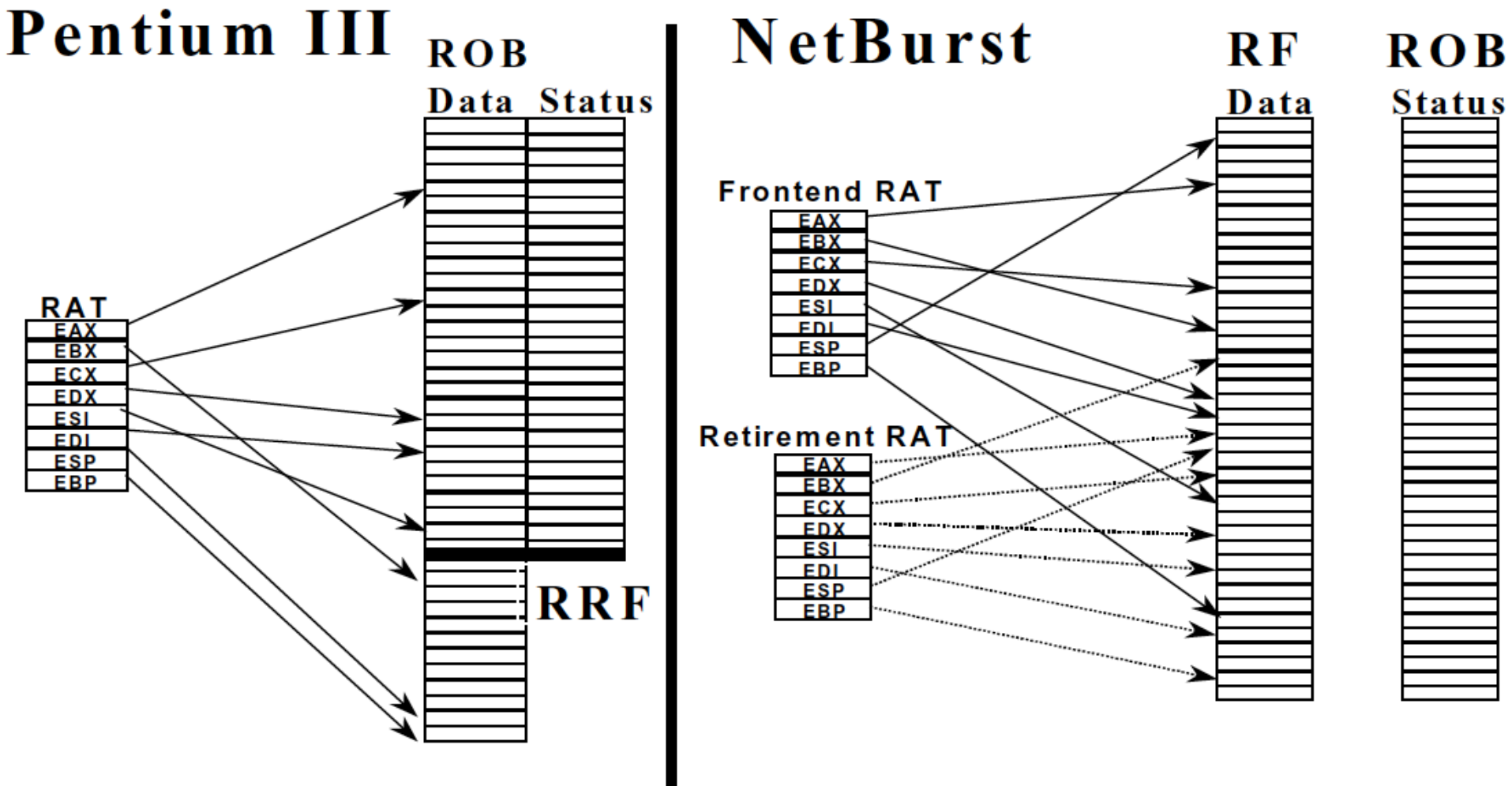

Boggs et al., "The Microarchitecture of the Pentium 4 Processor,"
Intel Technology Journal, 2001.

Enabling OoO Execution, Revisited

1. Link the consumer of a value to the producer
 - ❑ **Register renaming:** Associate a “tag” with each data value
2. Buffer instructions until they are ready
 - ❑ Insert instruction into **reservation stations** after renaming
3. Keep track of readiness of source values of an instruction
 - ❑ **Broadcast the “tag”** when the value is produced
 - ❑ Instructions **compare their “source tags”** to the broadcast tag
 - if match, source value becomes ready
4. When all source values of an instruction are ready, dispatch the instruction to functional unit (FU)
 - ❑ **Wakeup and select/schedule** the instruction

Summary of OOO Execution Concepts

- Register renaming eliminates false dependencies, enables linking of producer to consumers
- Buffering enables the pipeline to move for independent ops
- Tag broadcast enables communication (of readiness of produced value) between instructions
- Wakeup and select enables out-of-order dispatch

OOO Execution: Restricted Dataflow

- An out-of-order engine dynamically builds the dataflow graph of a piece of the program
 - which piece?
- The dataflow graph is limited to the instruction window
 - Instruction window: all decoded but not yet retired instructions
- Can we do it for the whole program?
- Why would we like to?
- In other words, how can we have a large instruction window?
- Can we do it efficiently with Tomasulo's algorithm?

Dataflow Graph for Our Example

MUL R3 \leftarrow R1, R2

ADD R5 \leftarrow R3, R4

ADD R7 \leftarrow R2, R6

ADD R10 \leftarrow R8, R9

MUL R11 \leftarrow R7, R10

ADD R5 \leftarrow R5, R11

State of RAT and RS in Cycle 7

end of cycle 7:

	V	tag	value
R1	1	~	1
R2	1	~	2
R3	0	X	~
R4	1	~	4
R5	0	d	~
R6	1	~	6
R7	0	b	~
R8	1	~	8
R9	1	~	9
R10	0	c	~
R11	0	Y	~

a	0	X	~	1	~	4
b	1	~	2	1	~	6
c	1	~	8	1	~	9
d	0	a	~	0	Y	~

X	1	~	1	1	~	2
Y	0	b	~	0	c	~

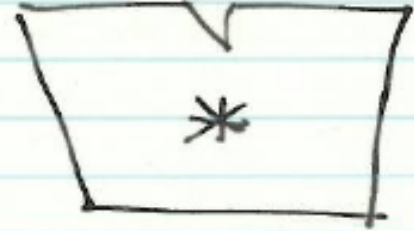
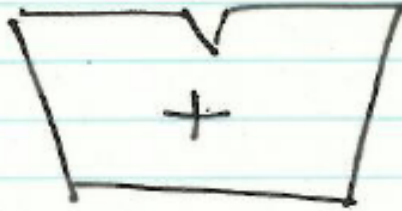

- * All 6 instructions renamed.
- Note what happened to R5

Dataflow Graph

MUL R1, R2 → R3 (x)
ADD R3, R4 → R5 (a)
ADD R2, R6 → R7 (b)
ADD R8, R9 → R10 (c)
MUL R7, R10 → R11 (y)
ADD R5, R11 → R5 (d)

Dataflow graph

Nodes: operations performed by the instruction

Arcs: tags in Tomasulo's algorithms

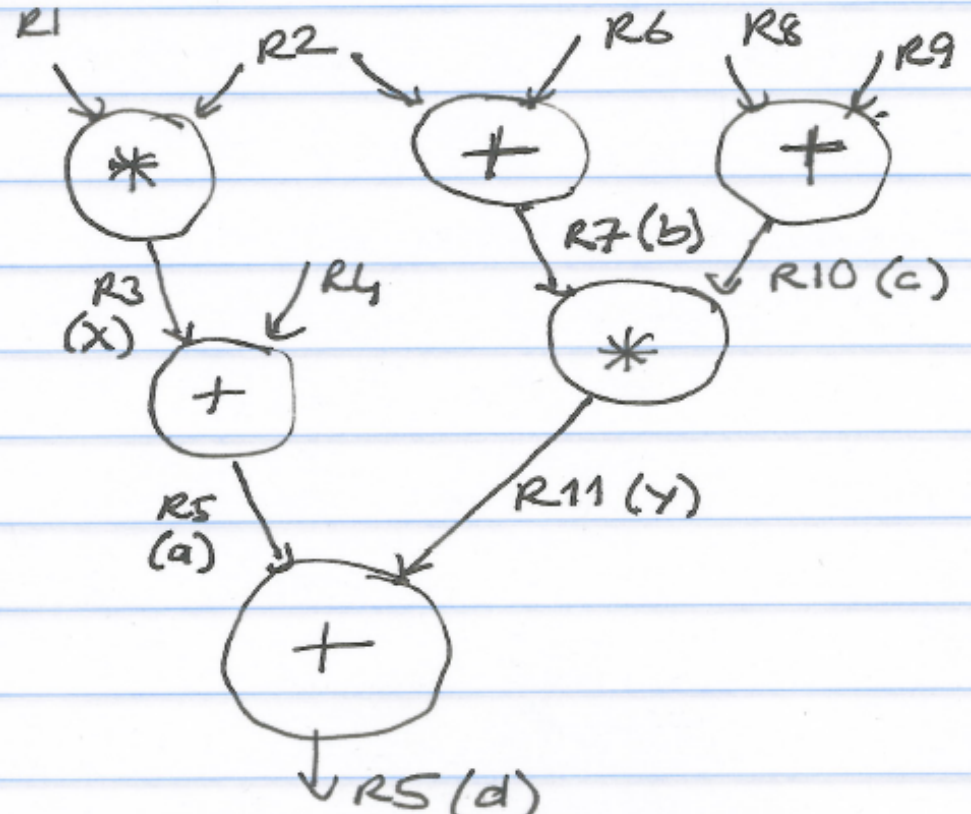

In-Class Exercise on Tomasulo

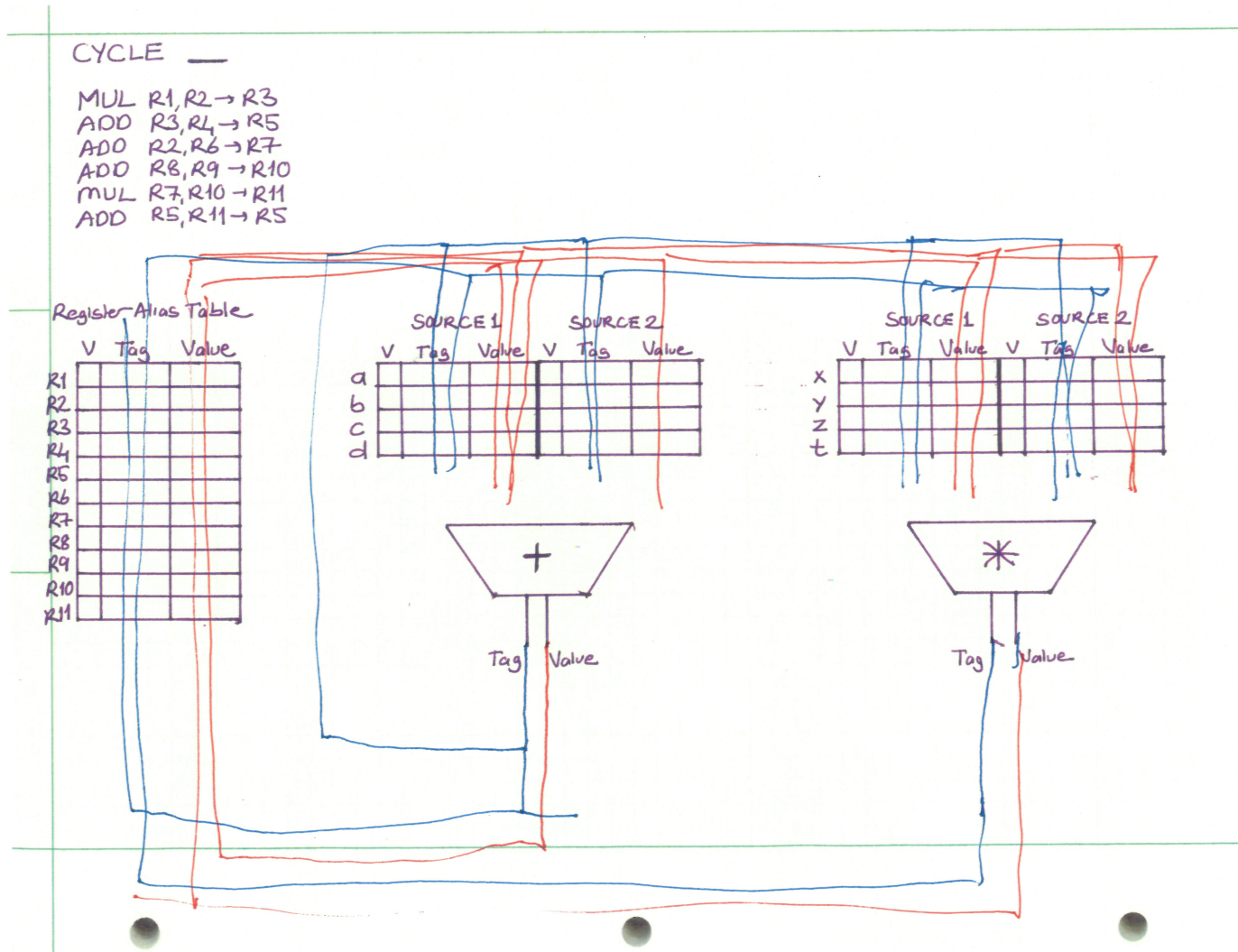

In-Class Exercise on Tomasulo

CYCLE 0

MUL R1,R2 → R3
 ADD R3,R4 → R5
 ADD R2,R6 → R7
 ADD R8,R9 → R10
 MUL R7,R10 → R11
 ADD R5,R11 → R5

Register Alias Table

	V	Tag	Value
R1			1
R2			2
R3			3
R4			4
R5			5
R6			6
R7			7
R8			8
R9			9
R10			10
R11			11

	SOURCE 1			SOURCE 2		
	V	Tag	Value	V	Tag	Value
a						
b						
c						
d						

	SOURCE 1			SOURCE 2		
	V	Tag	Value	V	Tag	Value
x						
y						
z						
t						

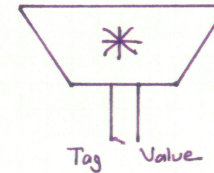
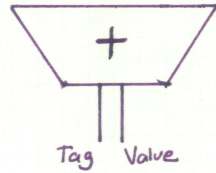

In-Class Exercise on Tomasulo

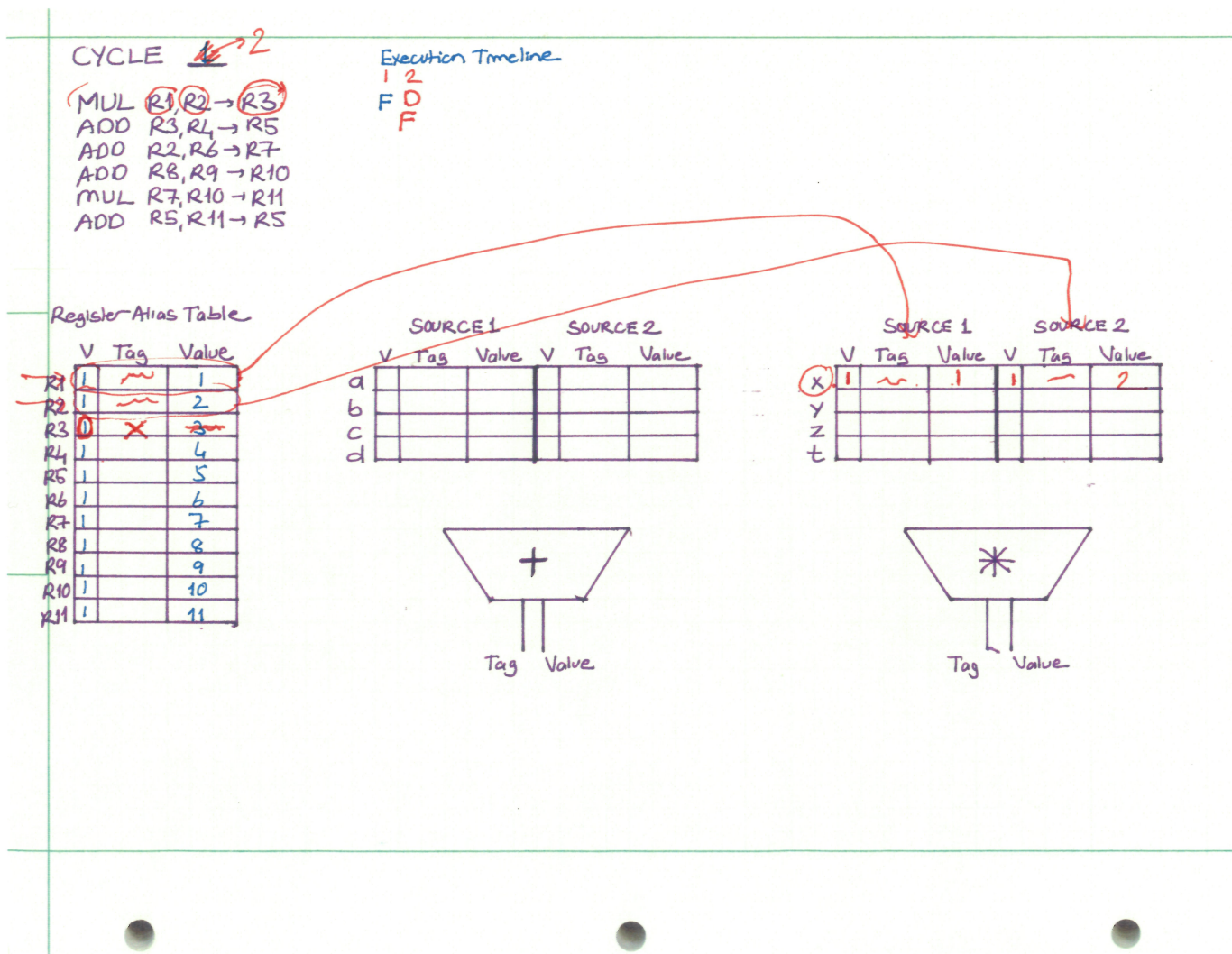

In-Class Exercise on Tomasulo

CYCLE ~~2~~³ Cycle 1 2

MUL R1, R2 → R3
 → ADD R3, R4 → R5
 ADD R2, R6 → R7
 ADD R8, R9 → R10
 MUL R7, R10 → R11
 ADD R5, R11 → R5

F D E_i
 F D F

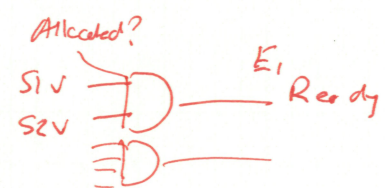

Register Alias Table

	V	Tag	Value
R1	1		1
R2	1		2
→ R3	0	PR5	
→ R4	1		4
→ R5	0	a	5
R6	1		6
R7	1		7
R8	1		8
R9	1		9
R10	1		10
R11	1		11

	SOURCE 1			SOURCE 2		
	V	Tag	Value	V	Tag	Value
a	0	PR5	~	1	~	4
b						
c						
d						

	SOURCE 1			SOURCE 2		
	V	Tag	Value	V	Tag	Value
x	1	-	1	1	-	2
y						
z						
t						

Dest PR5

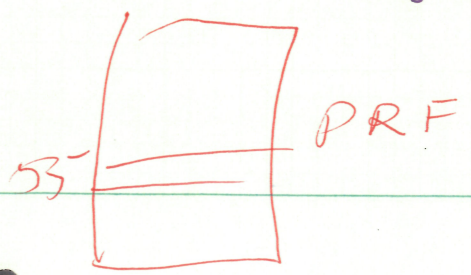
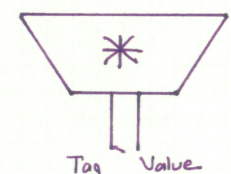
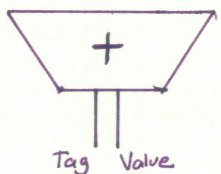

In-Class Exercise on Tomasulo

CYCLE ~~3~~⁴ Cycle. 1 2 3 4

```

MUL R1,R2 → R3
ADD R3,R4 → R5
→ ADD R2,R3 → R7
ADD R8,R9 → R10
MUL R7,R10 → R11
ADD R5,R11 → R5
    
```

F D E₁ E₂
F D -
F D -
F

Register Alias Table

	V	Tag	Value
R1	1	-	1
R2	1	-	2
R3	0	x	-
R4	1	-	4
R5	0	a	-
R6	1	-	6
R7	0	b	7
R8	1	-	8
R9	1	-	9
R10	1	-	10
R11	1	-	11

	SOURCE 1			SOURCE 2		
	V	Tag	Value	V	Tag	Value
a	0	x	-	1	-	4
b	1	-	2	1	-	6
c						
d						

	SOURCE 1			SOURCE 2		
	V	Tag	Value	V	Tag	Value
x	1	-	1	1	-	2
y						
z						
t						

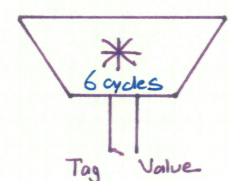
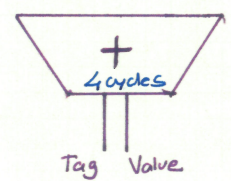

Does the tag HAVE TO be the ID of the Reservation Station Entry?

In-Class Exercise on Tomasulo

CYCLE ~~4~~⁵ Cycle. 1 2 3 4

MUL R1,R2 → R3 F D E E₂ E₃
 ADD R3,R4 → R5 F D - -
 → ADD R2,R6 → R7 F D E -
 → ADD R8,R9 → R10 F D -
 MUL R7,R10 → R11 F
 ADD R5,R11 → R5

Register Alias Table

	V	Tag	Value
R1	1		1
R2	1		2
R3	0	x	
R4	1		4
R5	0	a	
R6	1		6
R7	0	b	
R8	1		8
R9	1		9
R10	0	c	
R11	1		11

SOURCE 1 SOURCE 2

	V	Tag	Value	V	Tag	Value
a	0	x	-	1	-	4
b	1	-	2	1	-	6
c	1	-	8	1	-	9
d						

SOURCE 1 SOURCE 2

	V	Tag	Value	V	Tag	Value
x	1	-	1	1	-	2
y						
z						
t						

+

Tag Value

*

Tag Value

→ ADD at RS b can execute now (it is READY)
 → Both of its sources are READY
 It wakes up & it is selected to be executed
 Out of order dispatch into the functional unit

In-Class Exercise on Tomasulo

CYCLE ~~5~~ ⁶ Cycle 1 2 3 4 5

MUL R1, R2 → R3 F D E₁ E₂ E₃ E₄
 ADD R3, R4 → R5 F D - - -
 ADD R2, R6 → R7 ^a F D E₁ E₂
 ADD R8, R9 → R10 ^c F D E₁ E₂
~~MUL R7, R10 → R11~~ F D - - -
 ADD R5, R11 → R5 F - - - -

Register Alias Table

	V	Tag	Value
R1	1	-	1
R2	1	-	2
R3	0	x	-
R4	1	-	4
R5	0	a	-
R6	1	-	6
R7	0	b	-
R8	1	-	8
R9	1	-	9
R10	0	c	-
R11	0	y	-

	SOURCE 1			SOURCE 2		
	V	Tag	Value	V	Tag	Value
a	0	x	-	1	-	4
b	1	-	2	1	-	6
c	1	-	8	1	-	8
d						

	SOURCE 1			SOURCE 2		
	V	Tag	Value	V	Tag	Value
x	1	-	1	1	-	2
y	0	b	-	0	e	-
z						
t						

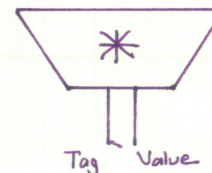
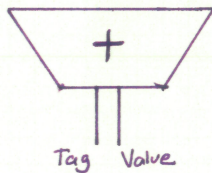

ADD at R5 c is READY to Execute

In-Class Exercise on Tomasulo

CYCLE 6

MUL R1, R2 → R3
 ADD R3, R4, R5
 ADD R2, R6 → R7
 ADD R8, R9 → R10
 MUL R7, R10 → R11
 ADD R5, R11 → R5

Cycle 1 2 3 4 5 6 7

F D E₁ E₂ E₃ E₄ E₅
 F D - - - -
 F D E₁ E₂ E₃
 F D E₁ E₂
 F D -
 F D

Register Alias Table

	V	Tag	Value
R1	1		1
R2	1		2
R3	0	x	
R4	1		4
R5	0	a	
R6	1		6
R7	0	b	
R8	1		8
R9	1		9
R10	0	c	
R11	0	y	

	SOURCE 1			SOURCE 2		
	V	Tag	Value	V	Tag	Value
a	0	x	-	1	-	4
b	1	-	2	1	-	6
c	1	-	8	1	-	9
d	0	a	-	0	y	-

	SOURCE 1			SOURCE 2		
	V	Tag	Value	V	Tag	Value
x	1	-	1	1	-	2
y						
z						
t						

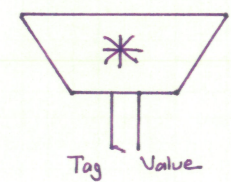
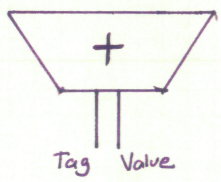

In-Class Exercise on Tomasulo

CYCLE ~~7~~ 8 Cycle 1 2 3 4 5 6 7 8

MUL R1, R2 → R3
ADD R3, R4 → R5
 ADD R2, R6 → R7
 ADD R8, R9 → R10
 MUL R7, R10 → R11
 ADD R5, R11 → R5

F D E₁ E₂ E₃ E₄ E₅ E₆ |
 F D - - - - - |
 F D E₁ E₂ E₃ E₄ |
 F D E₁ E₂ E₃ |
 F D - - - |
 F D - - - |

Register Alias Table

	V	Tag	Value
R1	1	-	1
R2	1	-	2
R3	1	x	2
R4	1	-	4
R5	0	d	-
R6	1	-	6
R7	0	b	8
R8	1	-	8
R9	1	-	9
R10	0	c	-
R11	0	y	-

	SOURCE 1			SOURCE 2		
	V	Tag	Value	V	Tag	Value
a	0	x	2	1	-	4
b	1	-	2	1	-	6
c	1	-	8	1	-	9
d	0	a	-	0	y	-

	SOURCE 1			SOURCE 2		
	V	Tag	Value	V	Tag	Value
x	1	-	1	1	-	2
y	1	b	8	0	c	-
z						
t						

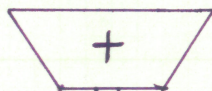

Tag: b
Value: 8



Tag: x
Value: 2

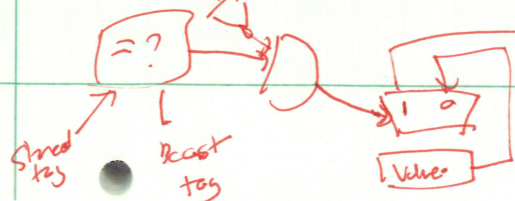

In-Class Exercise on Tomasulo

CYCLE ~~8~~ 9
 MUL R1, R2 → R3
 ADD R3, R4 → R5
 ADD R2, R6 → R7
 ADD R8, R9 → R10
 MUL R7, R10 → R11
 ADD R5, R11 → R5

Cycle 1 2 3 4 5 6 7 8 9
 F D E₁ E₂ E₃ E₄ E₅ E₆ PR W
 F D - - - - -
 F D E₁ E₂ E₃ E₄
 F D E₁ E₂ E₃
 F D - - -
 F D - - -

Clustering

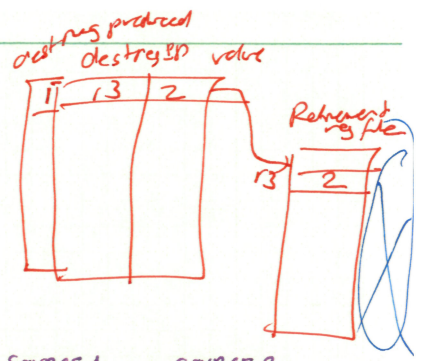

Future
 Register Alias Table

	V	Tag	Value
R1			
R2			
R3	1	x	2
R4			
R5			
R6	1	b	8
R7			
R8			
R9			
R10			
R11			

	SOURCE 1			SOURCE 2		
	V	Tag	Value	V	Tag	Value
a	1	x	2	1	-	4
b	1	-	2	1	-	6
c						
d						

	SOURCE 1			SOURCE 2		
	V	Tag	Value	V	Tag	Value
x	1	-	1	1	-	2
y	1	b	8	0	c	-
z						
t						

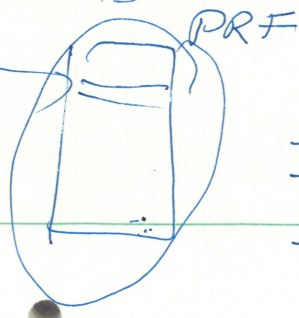
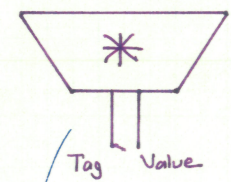
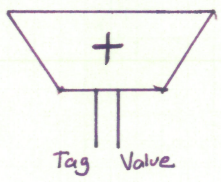

- MUL at RS x broadcasts its tag & value
- All RS and RAT entries waiting for the tag capture the value and set their V bits
- ADD at RS a becomes READY to execute now!

In-Class Exercise on Tomasulo

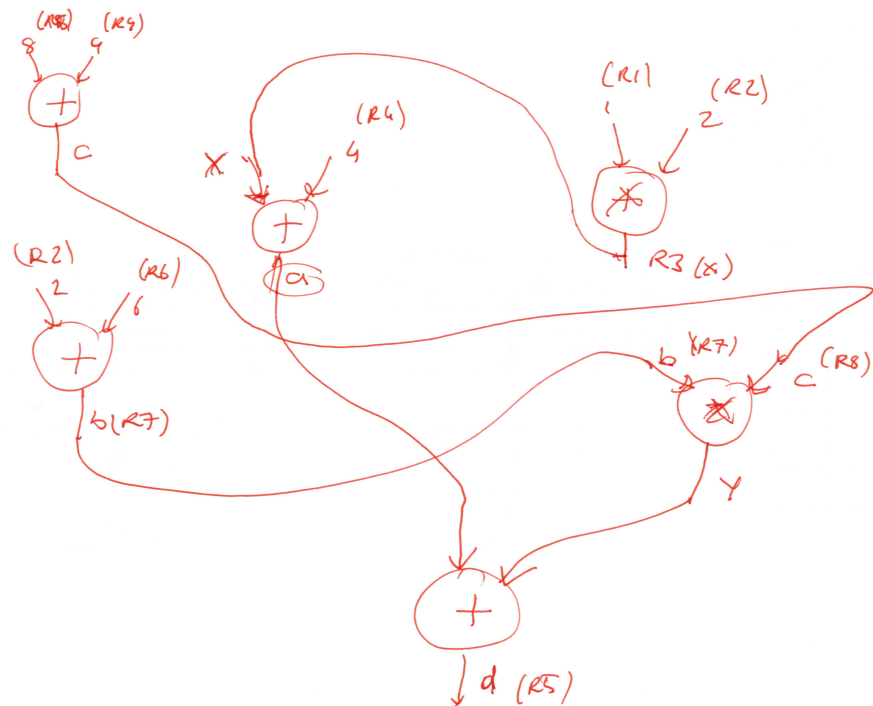

Tomasulo Template

CYCLE —

MUL R1, R2 → R3
 ADD R3, R4 → R5
 ADD R2, R6 → R7
 ADD R8, R9 → R10
 MUL R7, R10 → R11
 ADD R5, R11 → R5

Register Alias Table

	V	Tag	Value
R1			
R2			
R3			
R4			
R5			
R6			
R7			
R8			
R9			
R10			
R11			

	SOURCE 1			SOURCE 2		
	V	Tag	Value	V	Tag	Value
a						
b						
c						
d						

	SOURCE 1			SOURCE 2		
	V	Tag	Value	V	Tag	Value
x						
y						
z						
t						

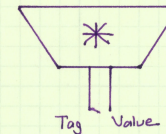
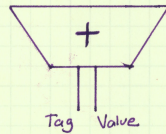

We did not cover the following slides in lecture.
These are for your preparation for the next lecture.

Restricted Data Flow

- An out-of-order machine is a “restricted data flow” machine
 - Dataflow-based execution is restricted to the microarchitecture level
 - ISA is still based on von Neumann model (sequential execution)

- Remember the data flow model (at the ISA level):
 - Dataflow model: An instruction is fetched and executed in data flow order
 - i.e., when its operands are ready
 - i.e., there is no instruction pointer
 - Instruction ordering specified by data flow dependence
 - Each instruction specifies “who” should receive the result
 - An instruction can “fire” whenever all operands are received

Questions to Ponder

- Why is OoO execution beneficial?
 - What if all operations take single cycle?
 - **Latency tolerance**: OoO execution tolerates the latency of multi-cycle operations by executing independent operations concurrently

- What if an instruction takes 500 cycles?
 - How large of an instruction window do we need to continue decoding?
 - How many cycles of latency can OoO tolerate?
 - **What limits the latency tolerance scalability of Tomasulo's algorithm?**
 - **Active/instruction window size**: determined by both scheduling window and reorder buffer size